



 **FixTrend**[®]
SZÉNACÉL RENDSZER



Zárt fűtési rendszer



Tűzvédelmi Sprinkler rendszerek



Hűtés



Hajóipar



Ipari felhasználás



Sűrített levegő ellátás

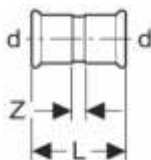

Szolár alkalmazás

KARMANTYÚ

Kód	d	L	Z	Súly gramm
C10AB	12	42	6	30
C10AC	15	52	10	36
C10AD	18	52	10	45
C10AE	22	59	13	60
C10AF	28	61	13	77
C10AG	35	72	18	103
C10AH	42	79	15	142
C10AJ	54	90	16	202
C10AK	76,1	142	32	619
C10AL	88,9	163	37	817
C10AM	108	192	38	1204

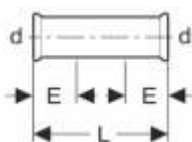
ÁTTOLÓ KARMANTYÚ

Kód	d	L	E	Súly gramm
C11AB	12	56	22	40
C11AC	15	75	24	51
C11AD	18	77	25	60
C11AE	22	86	27	81
C11AF	28	92	28	112
C11AG	35	99	31	136
C11AH	42	119	35	203
C11AJ	54	145	40	280
C11AK	76,1	230	60	875
C11AL	88,9	262	70	1200
C11AM	108	304	80	1705

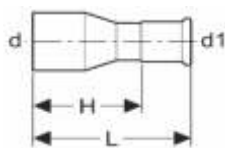
EGY TOKOS SZŰKÍTŐ

Kód	d-d1	L	H	Súly gramm
C12CB	15-12	51	33	26
C12DB	18-12	53	35	32
C12DC	18-15	55	34	36
C12EB	22-12	60	42	39
C12EC	22-15	60	39	42
C12ED	22-18	57	36	44
C12FB	28-12	75	57	55
C12FC	28-15	81	60	62
C12FD	28-18	84	63	68
C12FE	28-22	70	47	67
C12GC	35-15	84	63	84
C12GD	35-18	87	66	90
C12GE	35-22	76	53	95
C12GF	35-28	74	48	87
C12HD	42-18	98	77	180
C12HE	42-22	87	64	177
C12HF	42-28	100	76	128
C12HG	42-35	78	52	115
C12JD	54-18	108	87	190
C12JE	54-22	110	88	185
C12JF	54-28	100	76	185
C12JG	54-35	129	102	206
C12JH	54-42	108	76	189
C12KH	76,1-42	151	119	425
C12KJ	76,1-54	145	108	454
C12LJ	88,9-54	157	120	591
C12LK	88,9-76,1	157	105	660
C12MJ	108-54	204	167	880
C12MK	108-76,1	196	144	948
C12ML	108-88,9	192	133	962

SZÉNACÉL RENDSZER

KÉT TOKOS 90° ÍV



Kód	d	L	Z	Súly gramm
C20ZB	12	42	24	40
C20ZC	15	41	20	47
C20ZD	18	45	24	58
C20ZE	22	49	26	78
C20ZF	28	59	35	112
C20ZG	35	72	45	175
C20ZH	42	91	59	246
C20ZJ	54	110	73	395
C20ZK	76,1	150	95	977
C20ZL	88,9	174	111	1324
C20ZM	108	215	138	1991

EGY TOKOS 90° ÍV



Kód	d	L	H	Z	Súly gramm
C21ZB	12	42	48	24	35
C21ZC	15	41	49	20	47
C21ZD	18	45	53	24	58
C21ZE	22	49	59	26	80
C21ZF	28	59	69	35	113
C21ZG	35	72	83	45	175
C21ZH	42	91	96	59	250
C21ZJ	54	110	116	73	392
C21ZK	76,1	150	166	95	991
C21ZL	88,9	174	190	111	1329
C21ZM	108	215	230	138	1988

KÉT TOKOS 45° ÍV



Kód	d	L	Z	Súly gramm
C22ZB	12	32	14	34
C22ZC	15	30	9	39
C22ZD	18	31	10	47
C22ZE	22	35	12	63
C22ZF	28	41	17	90
C22ZG	35	56	29	150
C22ZH	42	63	31	201
C22ZJ	54	75	38	304
C22ZK	76,1	98	43	800
C22ZL	88,9	113	50	1034
C22ZM	108	138	61	1550

EGY TOKOS 45° ÍV

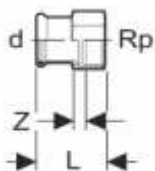

Kód	d	L	H	Z	Súly gramm
C23ZB	12	32	41	14	32
C23ZC	15	30	42	9	39
C23ZD	18	31	35	10	47
C23ZE	22	35	47	12	66
C23ZF	28	41	47	17	90
C23ZG	35	36	66	29	153
C23ZH	42	63	70	31	202
C23ZJ	54	75	82	38	316
C23ZK	76,1	98	119	43	800
C23ZL	88,9	113	130	50	1054
C23ZM	108	138	160	61	1580

**BELSŐ MENETES
ÁTMENETI IDOM**

Kód	d-Rp	L	Z	Súly gramm
C80NB	12-Rp $\frac{3}{8}$	31	3	40
C80PB	12-Rp $\frac{1}{2}$	35	5	45
C80NC	15-Rp $\frac{3}{8}$	35	4	65
C80PC	15-Rp $\frac{1}{2}$	37	4	70
C80QC	15-Rp $\frac{3}{4}$	38	4	71
C80PD	18-Rp $\frac{1}{2}$	37	4	57
C80QD	18-Rp $\frac{3}{4}$	38	4	75
C80PE	22-Rp $\frac{1}{2}$	37	3	87
C80QE	22-Rp $\frac{3}{4}$	40	4	80
C80RE	22-Rp1	43	4	114
C80PF	28-Rp $\frac{1}{2}$	45	9	191
C80QF	28-Rp $\frac{3}{4}$	43	6	139
C80RG	35-Rp1	45	8	130
C80SG	35-Rp1 $\frac{1}{4}$	73	25	300
C80TH	42-Rp1 $\frac{1}{2}$	75	20	270
C80VJ	54-Rp2	85	18	360

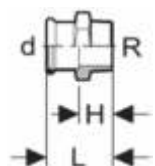
**KÜLSŐ MENETES
ÁTMENETI IDOM**

Kód	d-R	L	H	Súly gramm
C81NB	12-R $\frac{3}{8}$	36	18	38
C81PB	12-R $\frac{1}{2}$	40	22	45
C81NC	15-R $\frac{3}{8}$	43	22	41
C81PC	15-R $\frac{1}{2}$	43	22	55
C81QC	15-R $\frac{3}{4}$	44	23	87
C81PD	18-R $\frac{1}{2}$	44	23	65
C81QD	18-R $\frac{3}{4}$	45	24	79
C81PE	22-R $\frac{1}{2}$	44	21	75
C81QE	22-R $\frac{3}{4}$	45	22	95
C81RE	22-R1	47	24	154
C81QF	28-R $\frac{3}{4}$	47	23	101
C81RF	28-R1	49	25	107
C81SG	35-R1 $\frac{1}{4}$	54	27	169
C81TG	35-R1 $\frac{1}{2}$	54	27	172
C81TH	42-R1 $\frac{1}{2}$	58	26	226
C81VJ	54-R2	69	32	368
C81XK	76,1-R2 $\frac{1}{2}$	123	68	830
C81YL	88,9-R3	134	71	1160
C81ZM	108-R4	156	78	2005

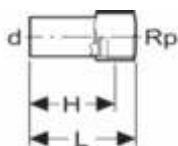
**BELSŐ MENETES
BETŐLŐ ÁTMENETI IDOM**

Kód	d-Rp	L	H	Súly gramm
C86NB	12-Rp $\frac{3}{8}$	54	44	52
C86PB	12-Rp $\frac{1}{2}$	58	46	60
C86NC	15-Rp $\frac{3}{8}$	74	64	57
C86PC	15-Rp $\frac{1}{2}$	61	49	60
C86PD	18-Rp $\frac{1}{2}$	61	49	62
C86QD	18-Rp $\frac{3}{4}$	64	51	91
C86PE	22-Rp $\frac{1}{2}$	61	49	65
C86QE	22-Rp $\frac{3}{4}$	65	52	93

KÜLSŐ MENETES BETOLÓ ÁTMENETI IDOM



Kód	d-R	H	Súly gramm
C87NB	12-R $\frac{3}{8}$	50	51
C87PB	12-R $\frac{1}{2}$	55	63
C87PC	15-R $\frac{1}{2}$	57	70
C87PD	18-R $\frac{1}{2}$	57	74
C87QD	18-R $\frac{3}{4}$	59	103
C87PE	22-R $\frac{1}{2}$	57	77
C87QE	22-R $\frac{3}{4}$	59	105

KÜLSŐ MENETES ÍV 90°



Kód	d-R	L	H	Z	Súly gramm
C83NB	12-R $\frac{3}{8}$	42	34	24	49
C83NC	15-R $\frac{3}{8}$	41	39	20	54
C83PC	15-R $\frac{1}{2}$	41	40	20	62
C83PD	18-R $\frac{1}{2}$	45	48	24	73
C83QE	22-R $\frac{3}{4}$	49	54	26	100
C83RF	28-R1	59	68	35	180
C83SG	35-R1 $\frac{1}{4}$	72	102	45	259
C83TH	42-R1 $\frac{1}{2}$	91	116	59	375
C83VJ	54-R2	110	142	73	670

BELSŐ MENETES ÍV 90°

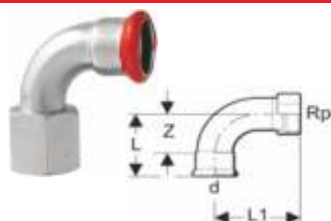

Kód	d-Rp	L	L1	Z	Súly gramm
C82NB	12-RP $\frac{3}{8}$	42	41	24	55
C82NC	15-RP $\frac{3}{8}$	41	44	20	60
C82PC	15-RP $\frac{1}{2}$	41	44	20	74
C82PD	18-RP $\frac{1}{2}$	45	51	24	84
C82QE	22-RP $\frac{3}{4}$	49	56	26	119
C82PF	28-RP $\frac{1}{2}$	59	64	35	97

BELSŐ MENETES KÖNYÖK

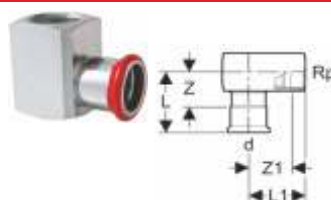

Kód	d-Rp	L	L1	Z	Z1	Súly gramm
C30PC	15-RP $\frac{1}{2}$	36	27	15	15	173
C30PD	18-RP $\frac{1}{2}$	36	27	15	15	169
C30PE	22-RP $\frac{1}{2}$	42	40	19	28	254
C30QE	22-RP $\frac{3}{4}$	42	30	19	17	285
C30PF	28-RP $\frac{1}{2}$	47	43	23	31	436

KÜLSŐ MENETES KÖNYÖK



Kód	d-R	L	H	Z	Súly gramm
C31NB	12-R $\frac{3}{8}$	34	21	16	73
C31NC	15-R $\frac{3}{8}$	34	23	13	82
C31PC	15-R $\frac{1}{2}$	34	28	13	95
C31PD	18-R $\frac{1}{2}$	36	26	15	110
C31QD	18-R $\frac{3}{4}$	37	31	16	150
C31QE	22-R $\frac{3}{4}$	39	36	16	189

EGÁL T-IDOM

Kód	d	L	L1	Z	Z1	I	Súly gramm
C40AB	12	56	35	10	17	28	48
C40AC	15	74	36	16	15	37	67
C40AD	18	80	37	19	16	40	82
C40AE	22	82	43	18	20	41	109
C40AF	28	92	46	22	22	46	144
C40AG	35	102	55	24	28	51	189
C40AH	42	118	60	27	28	59	270
C40AJ	54	142	73	34	36	71	396
C40AK	76,1	232	121	61	66	116	1150
C40AL	88,9	262	126	68	63	131	1600
C40AM	108	312	152	79	75	156	2319

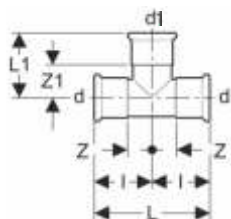
SZÚKÍTETT T-IDOM

Kód	d-d1-d	L	L1	Z	Z1	I	Súly gramm
C41BC	15-12-15	74	33	16	15	37	63
C41BD	18-12-18	80	34	19	16	40	74
C41CD	18-15-18	80	35	19	14	40	78
C41BE	22-12-22	82	36	18	18	41	94
C41CE	22-15-22	82	40	18	19	41	98
C41DE	22-18-22	82	40	18	19	41	100
C41CF	28-15-28	92	42	22	21	46	126
C41DF	28-18-28	92	43	22	22	46	128
C41EF	28-22-28	92	46	22	23	46	135
C41CG	35-15-35	102	45	24	24	51	159
C41DG	35-18-35	102	45	24	24	51	160
C41EG	35-22-35	102	48	24	25	51	169
C41FG	35-28-35	102	50	24	25	51	178
C41CH	42-15-42	118	52	27	31	59	224
C41DH	42-18-42	118	52	27	31	59	228
C41EH	42-22-42	118	54	27	31	59	233
C41FH	42-28-42	118	53	27	29	59	239
C41GH	42-35-42	118	57	27	30	59	254
C41CJ	54-15-54	142	54	34	33	71	349
C41DJ	54-18-54	142	54	34	33	71	354
C41EJ	54-22-54	142	56	34	33	71	360
C41FJ	54-28-54	142	59	34	35	71	339
C41GJ	54-35-54	142	64	34	37	71	350
C41HJ	54-42-54	142	68	34	36	71	378
C41EK	76,1-22-76,1	232	68	61	45	116	942
C41FK	76,1-28-76,1	232	71	61	47	116	956
C41GK	76,1-35-76,1	232	75	61	48	116	968
C41HK	76,1-42-76,1	232	79	61	47	116	981
C41JK	76,1-54-76,1	232	80	61	43	116	1 050
C41EL	88,9-22-88,9	262	76	68	53	131	1 256
C41FL	88,9-28-88,9	262	75,5	68	51,5	131	1 244
C41GL	88,9-35-88,9	262	83	68	56,5	131	1 267
C41HL	88,9-42-88,9	262	85	68	53	131	1 271
C41JL	88,9-54-88,9	262	92,5	68	55,5	131	1 297
C41KL	88,9-76,1-88,9	262	128	68	73	131	1 500
C41EM	108-22-108	312	85	79	62	156	1 838
C41FM	108-28-108	312	87,5	79	63,5	156	1 939
C41GM	108-35-108	312	93,5	79	66	156	1 955
C41HM	108-42-108	312	96	79	64	156	1 886
C41JM	108-54-108	312	102	79	65	156	1 967
C41KM	108-76,1-108	312	125	79	70,2	156	2 147
C41LM	108-88,9-108	312	135	79	72	156	2 184

T-IDOM BELSŐ MENETES ÁGGAL

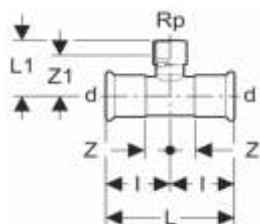

Kód	d - RP	L	L1	Z	Z1	I	Súly gramm
C42NB	12-R $\frac{3}{8}$ -12	56	33	10	23	28	68
C42PB	12-R $\frac{1}{2}$ -12	56	36	10	23	28	75
C42PC	15-R $\frac{1}{2}$ -15	74	38	16	23	37	82
C42PD	18-R $\frac{1}{2}$ -18	80	39	20	24	40	95
C42PE	22-R $\frac{1}{2}$ -22	82	42	18	30	41	113
C42QE	22-R $\frac{3}{4}$ -22	82	43	18	30	41	120
C42PF	28-R $\frac{1}{2}$ -28	92	44	22	32	46	140
C42QF	28-R $\frac{3}{4}$ -28	92	45	22	32	46	159
C42PG	35-R $\frac{1}{2}$ -35	102	48	24	36	51	176
C42QG	35-R $\frac{3}{4}$ -35	102	48	24	35	51	191
C42PH	42-R $\frac{1}{2}$ -42	118	46	27	34	59	250
C42QH	42-R $\frac{3}{4}$ -42	118	51	27	38	59	255
C42PJ	54-R $\frac{1}{2}$ -54	142	58	34	46	74	333
C42QJ	54-R $\frac{3}{4}$ -54	142	59	34	46	74	350
C42QK	76,1-R $\frac{3}{4}$ -76,1	232	69	61	56	116	950
C42QL	88,9-R $\frac{3}{4}$ -88,9	262	76	68	63	131	1 240
C42QM	108-R $\frac{3}{4}$ -108	312	86	79	73	156	1 830

SZŰKÍTETT T-IDOM

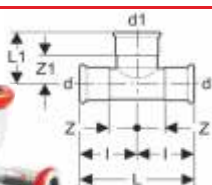
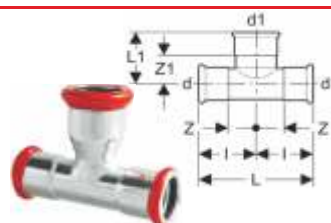

Kód	d - d1 - d	L	L1	Z	Z1	I	Súly gramm
C44CB	12-15-12	56	38	10	17	28	52
C44DC	15-18-15	74	36	16	15	37	71
C44EC	15-22-15	74	42	16	19	37	84
C44ED	18-22-18	80	45	19	22	40	97
C44FE	22-28-22	82	45	18	21	41	123

KITÉRŐ KERESZT IDOM

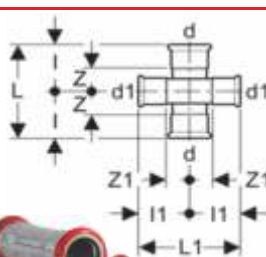
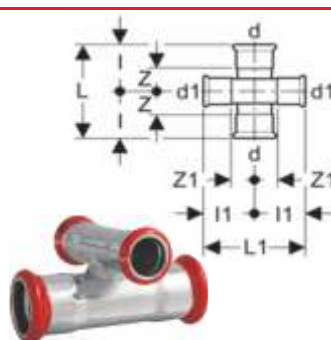

Kód	d - d1	L	L1	Z	Z1	I	I1	Súly gramm
C45AC	15-15	74	74	16	16	37	37	100
C45CD	18-15	80	74	19	16	40	37	110
C45CE	22-15	82	74	18	16	41	37	130
C45DE	22-18	82	80	18	19	41	40	140
C45CF	28-15	92	74	22	16	46	37	156
C45DF	28-18	92	80	22	19	46	40	166
C45EF	28-22	92	82	22	18	46	41	186
C45EG	35-22	102	82	24	18	51	41	218
C45EH	42-22	118	82	27	18	59	41	280
C45EJ	54-22	142	82	34	18	71	41	376

CSÖVÉGLEZÁRÓ KUPAK

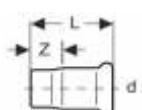

Kód	d	L	Z	Súly gramm
C50AB	12	30	12	20
C50AC	15	38	17	27
C50AD	18	41	20	35
C50AE	22	42	19	45
C50AF	28	46	22	62
C50AG	35	51	24	79
C50AH	42	59	27	123
C50AJ	54	73	36	179
C50AK	76,1	95	40	361
C50AL	88,9	115	52	495
C50AM	108	130	53	707

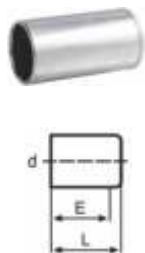
ZÁRÓDUGÓ

Kód	d	L	E	Súly gramm
C51AB	12	36	30	18
C51AC	15	42	33	25
C51AD	18	40	33	30
C51AE	22	43	34	41
C51AF	28	47	36	57
C51AG	35	49	40	76
C51AH	42	55	44	105
C51AJ	54	65	49	157
C51AK	76,1	87	74	350
C51AL	88,9	92	78	495
C51AM	108	107	92	702

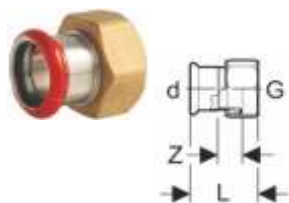
FÉLHOLLANDER

Kód	G - d	L	Z	Súly gramm
C60QC	G $\frac{3}{4}$ -15	37	11	69
C60QD	G $\frac{3}{4}$ -18	39	11	70
C60RE	G1-22	40	11	84
C60SF	G1 $\frac{1}{4}$ -28	44	13	156
C60TG	G1 $\frac{1}{2}$ -35	48	13	194

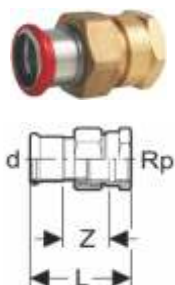
**BELSŐ MENETES
HOLLANDERES ÁTMENET**

Kód	d - Rp	L	Z	Súly gramm
C62PC	15-Rp $\frac{1}{2}$	59	26	188
C62QC	15-Rp $\frac{3}{4}$	61	26	157
C62PD	18-Rp $\frac{1}{2}$	59	26	190
C62QD	18-Rp $\frac{3}{4}$	61	26	158
C62QE	22-Rp $\frac{3}{4}$	63	27	184
C62RE	22-Rp1	66	28	212
C62RF	28-Rp1	71	31	388
C62SG	35-Rp1 $\frac{1}{4}$	77	32	429
C62TH	42-Rp1 $\frac{1}{2}$	82	33	509
C62VJ	54-Rp2	95	37	872

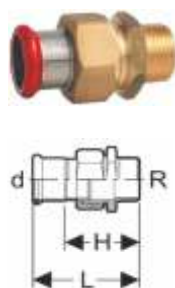
**KÜLSŐ MENETES
HOLLANDERES ÁTMENET**

Kód	d - R	L	H	Súly gramm
C64PC	15-R $\frac{1}{2}$	61	40	136
C64QC	15-R $\frac{3}{4}$	63	42	124
C64PD	18-R $\frac{1}{2}$	64	43	137
C64QD	18-R $\frac{3}{4}$	66	45	125
C64PE	22-R $\frac{1}{2}$	67	44	210
C64QE	22-R $\frac{3}{4}$	68	45	195
C64RE	22-R1	73	50	227
C64RF	28-R1	75	51	384
C64SG	35-R1 $\frac{1}{4}$	80	53	462
C64TH	42-R1 $\frac{1}{2}$	85	53	560
C64VJ	54-R2	97	60	863

FIX KARIMÁS ÁTMENET

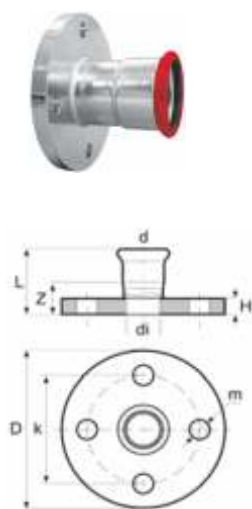

Kód	d	D	di	L	H	m	k	z	Súly gramm
PN 10/16									
C52AE	22	105	21	63	16	14	75	40	661
C52AF	28	115	27	67	16	14	85	43	814
C52AG	35	140	32	72	18	18	100	45	1 314
C52AH	42	150	41,8	80	18	18	110	48	1 523
C52AJ	54	165	54	96	18	18	125	59	1 721
C52AK	76,1	185	72	134	18	18	145	79	3 593
C52AL	88,9	200	85	141	20	18	160	78	4 615
C52AM	108	220	104	166	20	18	180	89	5 135

A 88,9 és a 108 méretű átmenetek (PN 10/16) 8 lyukkal vannak ellátva

PN 6

C53AE	22	90	21	61	14	11	65	38	1 009
C53AF	28	100	27	65	14	11	75	41	1 212
C53AG	35	120	32	70	16	14	90	43	1 991
C53AH	42	130	39	77	16	14	100	45	2 291
C53AJ	54	140	54	96	16	14	110	59	2 709
C53AK	76,1	160	72	130	14	14	130	75	2 144
C53AL	88,9	190	85	137	16	18	150	74	3 306
C53AM	108	210	104	162	16	18	170	85	4 033

TOK NÉLKÜLI KERÜLŐ IDOM

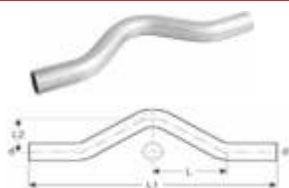

Kód	d	L1	L2	L	Súly gramm
C76AB	12	200	35	55	90
C76AC	15	202	37	64	110
C76AD	18	237	42	66	155
C76AE	22	233	42	58	159
C76AF	28	301	50	102	335

TOK NÉLKÜLI FÉLKERÜLŐ IDOM

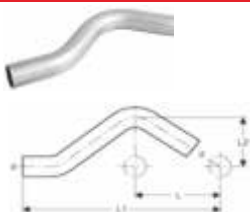

Kód	d	L1	L2	L	Súly gramm
C77AB	12	154	35	55	60
C77AC	15	145	37	57	80
C77AD	18	157	40	60	106
C77AE	22	175	52	65	147
C77AF	28	226	65	74	249

CSŐÍV



Kód	d	H1	H	K	K1	Súly gramm
C70AB	12	120	70	17	67	72
C70AC	15	120	70	22	72	88
C70AD	18	120	70	17	67	103
C70AE	22	120	70	9	59	132
C70AF	28	125	97	7	47	190
C70AG	35	201	121	62	62	359
C70AH	42	254	160	90	90	553
C70AJ	54	302	202	45	45	877
C70AK	76,1	250	250	62	60	1 752
C70AL	88,9	291	291	90	90	2 532
C70AM	108	364	364	45	45	3 604

HEGESZTHETŐ TOK

* Nem horganyzott

Kód	d	L	Súly gramm
C17AB	12	23	12
C17AC	15	25	17
C17AD	18	25	21
C17AE	22	27	29
C17AF	28	30	36
C17AG	35	34	50
C17AH	42	38	65
C17AJ	54	44	97
C17AK	76,1	68	282
C17AL	88,9	78	375
C17AM	108	94	578

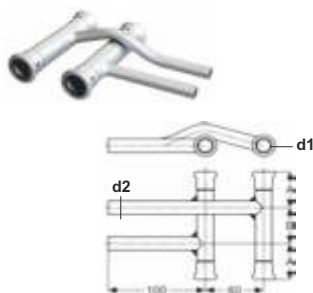
EGYSZERES STRANGELÁGAZÓ

Kód	d1-d2	A	B	Súly gramm
C91CC	15-15	40	40	250
C91BD	18-12	40	40	270
C91CD	18-15	40	40	280
C91BE	22-12	40	40	300
C91CE	22-15	40	40	320
C91BF	28-12	40	40	430
C91CF	28-15	40	40	450

KETTŐS STRANGELÁGAZÓ

Kód	d1-d2	A	B	Súly gramm
C90BB	12-12	30	40	305
C90BC	15-12	40	40	330
C90CC	15-15	40	40	355
C90BD	18-12	40	40	370
C90CD	18-15	40	40	380
C90CE	22-15	40	40	420
C90BF	28-12	40	40	530
C90CF	28-15	40	40	560
C90CG	35-15	40	40	660

LPP O-GYŰRŰ

STANDARD rozsdamentes és szénacél idomokhoz víz közegehez



Kód	d	E	C	Súly gramm
008875	12	12	2,4	0,3
008876	15	15	2,6	0,3
008877	18	18	2,6	0,4
008878	22	22	3,2	0,7
008879	28	28	3,1	0,8
008880	35	35	3,1	1,0
008881	42	42	4,1	2,2
008882	54	54	4,1	2,8

Üzemi hőmérséklet: -20°C - 85°C
Max. hőmérséklet: 120°C

SZÉNACÉL RENDSZER

O-GYŰRŰ

STANDARD rozsdamentes
és szénacél idomokhoz
szolár rendszerekhez 170 °C-ig



Kód	d	E	C	Súly gramm
002485	12	12	2,4	0,3
002849	15	15	2,6	0,3
002850	18	18	2,6	0,4
002851	22	22	3,2	0,7
002852	28	28	3,1	0,8
002853	35	35	3,1	1,0
002854	42	42	4,1	2,2
002855	54	54	4,1	2,8
002983	76,1	76,8	8	11,5
002984	88,9	89,3	8,2	17,5
002985	108	108,6	11	33,8

KÍVÜL HORGANYZOTT

TŰZIHORGANYZOTT SZÉNACÉL CSŐ



Kód	d	Falvastagság (mm)	Hossz (m)	Súly kg/m
TUCZ012-6	12	1	6	0,319
TUCZ015-6	15	1,2	6	0,408
TUCZ018-6	18	1,2	6	0,497
TUCZ022-6	22	1,5	6	0,758
TUCZ028-6	28	1,5	6	0,980
TUCZ035-6	35	1,5	6	1,239
TUCZ042-6	42	1,5	6	1,498
TUCZ054-6	54	1,5	6	1,942
TUCZ076-6	76,1	2	6	3,655
TUCZ088-6	88,9	2	6	4,286
TUCZ108-6	108	2	6	5,228

HORGANYZOTT SZÉNACÉL CSŐ



Kód	d	Falvastagság (mm)	Hossz (m)	Súly kg/m
TUCZE012	12	1	6	0,319
TUCZE015	15	1,2	6	0,408
TUCZE018	18	1,2	6	0,497
TUCZE022	22	1,5	6	0,758
TUCZE028	28	1,5	6	0,980
TUCZE035	35	1,5	6	1,239
TUCZE042	42	1,5	6	1,498
TUCZE054	54	1,5	6	1,942
TUCZE076	76,1	2	6	3,655
TUCZE088	88,9	2	6	4,286
TUCZE108	108	2	6	5,228

KÍVÜL-BELÜL HORGANYZOTT

HORGANYZOTT SZÉNACÉL CSŐ



Kód	d	Falvastagság (mm)	Hossz (m)	Súly kg/m
TUCZI015	15	1,2	6	0,408
TUCZI018	18	1,2	6	0,497
TUCZI022	22	1,5	6	0,758
TUCZI028	28	1,5	6	0,980
TUCZI035	35	1,5	6	1,239
TUCZI042	42	1,5	6	1,498
TUCZI054	54	1,5	6	1,942
TUCZI076	76,1	2	6	3,655
TUCZI088	88,9	2	6	4,286
TUCZI108	108	2	6	5,228

FELHASZNÁLÁSI TERÜLETEK

A Fixtrend szénacél rendszer alkalmazási területei olyan polgári és ipari létesítmények, ahol a nemesacél csövezés nem szükséges. Használati víz rendszerekhez nem használható.

Tipikus alkalmazások:

- Zárt rendszerű fűtési és hűtési rendszerek
- Sűrített levegő és semleges gáz rendszerek
- Tűzvédelmi Sprinkler rendszerek
- A glikol közeg koncentrációja maximum 50% -os lehet!
- A cinkkel belsőleg bevont szénacél csövek esetén NEM használható!

A fekete EPDM O-gyűrű tömítés ellenáll az öregedésnek, hő-és kémiai adalékanyagoknak, ezért különösen alkalmas minden az előbbieken felsorolt típusú rendszerekbe történő beépítésre.

FELHASZNÁLÁSI FELTÉTELEK

- Maximális üzemi nyomás: 16 bar
- Működési hőmérséklet: - 20 °C + 85 °C
- Maximális hőmérséklet: 120 °C
- Próbanyomás értéke: üzemi nyomás 1,5 szerese
- A tárolás és a felhasználás alatti tartós külső nedvesség hatás ellen védeni kell

CSŐFEKTETÉS ÉS HŐTÁGULÁS

A csövek hossza a hőmérséklet-változás hatására akár jelentősen is megváltozhat. Ezért a csövezeték rendszerek telepítésekor három szabályt kell figyelembe venni annak érdekében, hogy üzemeltetésük során ne keletkezzenek meghibásodások.

1. Legyen elegendő hely a meghosszabodott csövezeték számára.
2. Alkalmazzunk hőtágulási kompenzátorokat.
3. Helyesen határozzuk meg a fix, valamint a csúszó rögzítési pontok helyzetét.

A következő képlet használható a hosszanti megnyúlás kiszámításához: $\Delta L = \alpha \times L \times \Delta T$ ahol:

- ΔL : hosszváltozás (mm)
- α : az anyag lineáris hő tágulási együtthatója (1/K)
- L: a cső hossza (mm)
- ΔT : maximális hőmérséklet-változás (K)

SZERSZÁMOK

A préseléshez bármelyik kereskedelmi forgalomban kapható prészsorszám használható.

Elektromechanikus gépek: Akkumulátoros vagy a hálózati feszültséggel üzemelő változatokat (220 V - 110 V - 48 V), egyaránt lehet használni a teljes méretválasztékban.

Elektrohidraulikus eszközöket elsősorban a nagyobb átmérőknél 76,1-108 mm célszerű használni.

A Fixtrend szénacél rendszerhez bármilyen gyártmányú M profillal rendelkező présfofa használható.

A vágáshoz csak görgőscsővágót szabad használni.

A csövek melegen nem hajlíthatók, a hideg csőhajlítás 42 mm-ig megengedett $R_{\min} = 3,5d_k$ feltétel betartásával.



DANISH
TECHNOLOGICAL
INSTITUTE